



The Only Real Alternative

2012 Price List (£)

Tiger Filtration Ltd - The Only Real Alternative

Alternative Filter Elements

Contents



Alternative Filter Elements	Page No.	Alternatives Cont....	Page No.
Abac	1	Hydrovane - Air/Oil Separators	25
ALMiG	2	Ingersoll Rand	26
Atlas Copco - Present Range	3	Kaeser	27
Atlas Copco - Previous Range	4	Leybold	28
Atlas Copco - Previous Range	5	Mark	29
A.F.E.	6	Mattei	30
Becker	7	Mattei - Air/Oil Separators	31
BOGE	8	MiKROPOR	32
Busch	9	MTA	33
Ceccato	10	Omega	34
Compair - Present Range	11	OMI - Present Range	35
Compair - Previous Range	12	OMI - Previous Range	36
CTA	13	Pneumatech	37
Deltech	14	Puska	38
Domnick Hunter - Present Range	15	Rietschle	39
Domnick Hunter - Previous Range	16	Sullair	40
Domnick Hunter - Previous Range	17	Ultrafilter - 90 Series	41
Edwards	18	Ultrafilter - 80 Series	42
Friulair - FT Range	19	Walker - Present Range	43
Friulair - FL Range	20	Walker - Previous Range	44
Hankison	21	Worthington Creyssensac	45
Hiross	22	Zander	46
HPC	23	Zeks	47
Hydrovane	24		

Quality Products from Tiger Filtration Ltd - Our range of Alternative Elements are designed and manufactured to perform "as good if not better" than the original equipment. All the materials used in the manufacture of these elements are sourced from recognised suppliers to the industry.

We are so confident in our products that we offer a full 12 months "money back" guarantee if you are not happy with the performance.

When you buy a product from **Tiger Filtration Ltd** you get a promise from the Managing Director that the elements are "as good if not better" than the original.



Tiger Filtration Ltd
 Units 4a & 4b, East Way, Rivergreen Industry Centre, Pallion, Sunderland, SR4 6AD, UK
 Tel: +44 (0) 191 565 5348 Fax: +44 (0) 191 564 0002 Email: sales@tigerfiltration.co.uk



Tiger Filtration Ltd

Alternative Filter Elements

Abac

Alternative filter elements manufactured by **Tiger Filtration Ltd** to fit into **Abac** filter housings



Tiger P/No.	Abac P/No.	List Price £
AB60 (*)	(*) 60	21.00
AB80 (*)	(*) 80	24.00
AB120 (*)	(*) 120	33.00
AB200 (*)	(*) 200	42.00
AB340 (*)	(*) 340	56.00
AB510 (*)	(*) 510	69.00
AB800 (*)	(*) 800	87.00
AB1000 (*)	(*) 1000	118.00
AB1500 (*)	(*) 1500	140.00
AB2400 (*)	(*) 2400	222.00

(*) = grade - Example: APFC60 order as AB60 M1

M3 replaces AQFC (3 Micron)

M1 replaces APFC (1 Micron)

M0 replaces AEFC (0.1 Micron)

MX replaces AHFC (0.01 Micron & 0.01mg/m³ oil removal)

AC replaces ACFC (Activated Carbon)



Tiger Filtration Ltd

Units 4a & 4b, East Way, Rivergreen Industry Centre, Pallion, Sunderland, SR4 6AD, UK

Tel: +44 (0) 191 565 5348 Fax: +44 (0) 191 564 0002 Email: sales@tigerfiltration.co.uk

Tiger Filtration Ltd

Alternative Filter Elements

ALMiG

Alternative filter elements manufactured by **Tiger Filtration Ltd** to fit into **ALMiG** filter housings



Tiger P/No.	Almig P/No.	List Price £
AL30 (*)	(*) 30	23.00
AL60 (*)	(*) 60	27.00
AL108 (*)	(*) 108	36.00
AL180 (*)	(*) 180	38.00
AL204 (*)	(*) 204	41.00
AL300 (*)	(*) 300	48.00
AL432 (*)	(*) 432	54.00
AL570 (*)	(*) 570	72.00
AL750 (*)	(*) 750	93.00
AL990 (*)	(*) 990	113.00
AL1140 (*)	(*) 1140	122.00
AL1320 (*)	(*) 1320	160.00

(*) = grade - Example: AFM30 order as AL30 M1

M5 replaces AFP (3 Micron)

M1 replaces AFM (1 Micron)

MX replaces AFS (0.01 Micron & 0.01mg/m³ oil removal)

AC replaces AFC (Activated Carbon)



Tiger Filtration Ltd

Units 4a & 4b, East Way, Rivergreen Industry Centre, Pallion, Sunderland, SR4 6AD, UK

Tel: +44 (0) 191 565 5348 Fax: +44 (0) 191 564 0002 Email: sales@tigerfiltration.co.uk

Tiger Filtration Ltd

Alternative Filter Elements

Atlas Copco

Alternative filter elements manufactured by **Tiger Filtration Ltd** to fit into **Atlas Copco** filter housings



Grade M1 (DDp) 1 Micron

Tiger P/No.	AC P/No.	List Price £
AC9 M1	2901 0520 00	66.00
AC17 M1	2901 0613 00	87.00
AC32 M1	2901 0526 00	123.00
AC44 M1	2901 0529 00	141.00
AC60 M1	2901 0532 00	172.00
AC120 M1	2901 0535 00	208.00
AC150 M1	2901 0538 00	226.00
AC175 M1	2901 0541 00	241.00
AC260 M1	2901 0544 00	320.00
AC280 M1	2901 0544 00	320.00
AC390 M1	2906 7000 00	379.00
AC520 M1	2906 7003 00	434.00
AC-AX M1	1617 7073 03	355.00

Grade M1 (DD) 1 Micron & 0.1mg/m³ oil removal

Tiger P/No.	AC P/No.	List Price £
AC9 M1	2901 0520 00	66.00
AC17 M1	2901 0613 00	87.00
AC32 M1	2901 0526 00	123.00
AC44 M1	2901 0529 00	141.00
AC60 M1	2901 0532 00	172.00
AC120 M1	2901 0535 00	208.00
AC150 M1	2901 0538 00	226.00
AC175 M1	2901 0541 00	241.00
AC260 M1	2901 0544 00	320.00
AC280 M1	2901 0544 00	320.00
AC390 M1	2906 7000 00	379.00
AC520 M1	2906 7003 00	434.00
AC-AX M1	1617 7073 03	355.00

Grade MX (PD) 0.01 Micron

Tiger P/No.	AC P/No.	List Price £
AC9 MX	2901 0521 00	66.00
AC17 MX	2901 0524 00	87.00
AC32 MX	2901 0527 00	123.00
AC44 MX	2901 0530 00	141.00
AC60 MX	2901 0533 00	172.00
AC120 MX	2901 0536 00	208.00
AC150 MX	2901 0539 00	226.00
AC175 MX	2901 0542 00	241.00
AC260 MX	2901 0545 00	320.00
AC280 MX	2901 0545 00	320.00
AC390 MX	2906 7001 00	379.00
AC520 MX	2906 7004 00	434.00
AC-AX MX	1617 7073 01	355.00

Grade AC (QD) Activated Carbon

Tiger P/No.	AC P/No.	List Price £
AC9 AC	2901 614 00	66.00
AC17 AC	2901 0525 00	87.00
AC32 AC	2901 0528 00	123.00
AC44 AC	2901 0531 00	141.00
AC60 AC	2901 0534 00	172.00
AC120 AC	2901 0537 00	208.00
AC150 AC	2901 0540 00	226.00
AC175 AC	2901 0543 00	241.00
AC260 AC	2901 0546 00	320.00
AC280 AC	2901 0546 00	320.00
AC390 AC	2906 7002 00	379.00
AC520 AC	2906 7005 00	434.00
AC-AX AC	1617 7073 02	355.00



Tiger Filtration Ltd

Units 4a & 4b, East Way, Rivergreen Industry Centre, Pallion, Sunderland, SR4 6AD, UK

Tel: +44 (0) 191 565 5348 Fax: +44 (0) 191 564 0002 Email: sales@tigerfiltration.co.uk

Tiger Filtration Ltd

Atlas Copco - Previous

Alternative filter elements manufactured by **Tiger Filtration Ltd** to fit into **Atlas Copco** filter housings

Alternative Filter Elements



Grade M1 (DD)		1 Micron
Tiger P/No.	AC P/No.	List Price £
AC190 M1	2901-0190-00	47.00
AC191 M1	2901-0191-00	75.00
AC234 M1	2901-0234-00	85.00
AC192 M1	2901-0192-00	106.00
AC193 M1	2901-0193-00	137.00
AC194 M1	2901-0194-00	167.00
AC213 M1	2906-0213-00	364.00
AC212 M1	2906-0212-00	277.00

Grade MX (PD)		0.01 Micron
Tiger P/No.	AC P/No.	List Price £
AC195 MX	2901-0195-00	47.00
AC196 MX	2901-0196-00	75.00
AC233 MX	2901-0233-00	85.00
AC197 MX	2901-0197-00	106.00
AC198 MX	2901-0198-00	137.00
AC199 MX	2901-0199-00	167.00
AC215 MX	2906-0215-00	364.00
AC214 MX	2906-0214-00	277.00

Grade AC (QD)		Activated Carbon
Tiger P/No.	AC P/No.	List Price £
AC206 AC	2901-0206-00	225.00
AC201 ACC	2901-0201-00	27.00
AC203 ACC	2901-0203-00	44.00
AC235 ACC	2901-0235-00	86.00
AC205 ACC	2901-0205-00	112.00
AC217 AC	2901-0217-00	364.00
AC202 ACC	2901-0202-00	30.00
AC204 ACC	2901-0204-00	62.00
AC216 AC	2906-0216-00	277.00

Grade M1 (DD)		1 Micron
Tiger P/No.	AC P/No.	List Price £
AC625502 M1	1202-6255-02	47.00
AC625702 M1	1202-6257-02	75.00
AC625704 M1	1202-6257-04	85.00
AC625902 M1	1202-6259-02	106.00
AC625904 M1	1202-6259-04	137.00
AC626202 M1	1202-6262-02	167.00
AC857302 M1	1202-8573-02	277.00
AC627302 M1	1202-6273-02	364.00
AC626204 M1	1202-6262-04	218.00

Grade MX (PD)		0.01 Micron
Tiger P/No.	AC P/No.	List Price £
AC625501 MX	1202-6255-01	47.00
AC625701 MX	1202-6257-01	75.00
AC625703 MX	1202-6257-03	85.00
AC625901 MX	1202-6259-01	106.00
AC625903 MX	1202-6259-03	137.00
AC626201 MX	1202-6262-01	167.00
AC857301 MX	1202-8573-01	277.00
AC627301 MX	1202-6273-01	364.00
AC626203 MX	1202-6262-03	218.00

Grade AC (QD)		Activated Carbon
Tiger P/No.	AC P/No.	List Price £
AC626400 ACC	1202-6264-00	27.00
AC628101 ACC	1202-6281-01	30.00
AC626801 ACC	1202-6268-01	44.00
AC628102 ACC	1202-6281-02	62.00
AC626802 ACC	1202-6268-02	86.00
AC626803 ACC	1202-6268-03	112.00
AC626301 AC	1202-6263-01	167.00
AC857200 AC	1202-8572-00	277.00
AC627400 AC	1202-6274-00	364.00
AC626302 AC	1202-6263-02	218.00

ACC = AC Element For Duplex Housing



Tiger Filtration Ltd

Units 4a & 4b, East Way, Rivergreen Industry Centre, Pallion, Sunderland, SR4 6AD, UK

Tel: +44 (0) 191 565 5348 Fax: +44 (0) 191 564 0002 Email: sales@tigerfiltration.co.uk

Tiger Filtration Ltd

Alternative Filter Elements

Atlas Copco - Previous

Alternative filter elements manufactured by **Tiger Filtration Ltd** to fit into **Atlas Copco** filter housings



Grade M5 (UFD)		5 Micron
Tiger P/No.	AC P/No.	List Price £
AC925 M5	9703-1925	89.00
AC926 M5	9703-1926	103.00
AC927 M5	9703-1927	133.00
AC928 M5	9703-1928	174.00
AC929 M5	9703-1929	198.00
AC930 M5	9703-1930	259.00
AC931 M5	9703-1931	342.00

Grade M1 (UDD)		1 Micron
Tiger P/No.	AC P/No.	List Price £
AC420 M1	9703-1420	89.00
AC421 M1	9703-1421	103.00
AC422 M1	9703-1422	133.00
AC423 M1	9703-1423	174.00
AC424 M1	9703-1424	198.00
AC425 M1	9703-1425	259.00
AC426 M1	9703-1426	342.00

Grade MX (UPD)		0.01 Micron oil removal
Tiger P/No.	AC P/No.	List Price £
AC442 MX	9703-1442	89.00
AC443 MX	9703-1443	103.00
AC444 MX	9703-1444	133.00
AC445 MX	9703-1445	174.00
AC446 MX	9703-1446	198.00
AC447 MX	9703-1447	259.00
AC448 MX	9703-1448	342.00

Grade AC (AC)		Activated Carbon
Tiger P/No.	AC P/No.	List Price £
AC431 AC	9703-1431	89.00
AC432 AC	9703-1432	103.00
AC433 AC	9703-1433	133.00
AC434 AC	9703-1434	174.00
AC435 AC	9703-1435	198.00
AC436 AC	9703-1436	259.00
AC437 AC	9703-1437	342.00



Tiger Filtration Ltd

Units 4a & 4b, East Way, Rivergreen Industry Centre, Pallion, Sunderland, SR4 6AD, UK

Tel: +44 (0) 191 565 5348 Fax: +44 (0) 191 564 0002 Email: sales@tigerfiltration.co.uk

Tiger Filtration Ltd

Alternative Filter Elements

A.F.E.

Alternative filter elements manufactured by **Tiger Filtration Ltd** to fit into **A.F.E.** filter housings



Tiger P/No.	AFE P/No.	List Price £
AF10 (*)	EA10 (*)	43.00
AF15 (*)	EA15 (*)	51.00
AF20 (*)	EA20 (*)	59.00
AF30 (*)	EA30 (*)	75.00
AF55 (*)	EA55 (*)	98.00
AF95 (*)	EA95 (*)	127.00
AF150 (*)	EA150 (*)	163.00
AF220 (*)	EA220 (*)	202.00
AF290 (*)	EA290 (*)	268.00
AF430 (*)	EA430 (*)	317.00
AF625 (*)	EA625 (*)	448.00
AF775 (*)	EA775 (*)	587.00

(*) = grade - Example: EA10U order as AF10 M1
 M3 replaces P (3 Micron)
 M1 replaces U (1 Micron)
 MX replaces H (0.01 Micron & 0.01mg/m³ oil removal)
 AC replaces C (Activated Carbon)

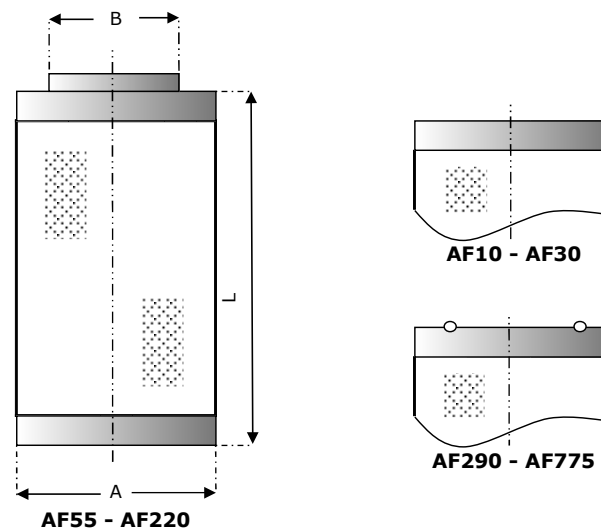

Tiger P/No.	A (mm)	B (mm)	L (mm)
AF10 (*)	51	n/a	50
AF15 (*)	51	n/a	61
AF20 (*)	51	n/a	72
AF30 (*)	51	n/a	140
AF55 (*)	75	63	110
AF95 (*)	75	63	210
AF150 (*)	75	63	310
AF220 (*)	75	63	500
AF290 (*)	91	n/a	509
AF430 (*)	91	n/a	766
AF625 (*)	140	n/a	616
AF775 (*)	140	n/a	751



Tiger Filtration Ltd
 Units 4a & 4b, East Way, Rivergreen Industry Centre, Pallion, Sunderland, SR4 6AD, UK
 Tel: +44 (0) 191 565 5348 Fax: +44 (0) 191 564 0002 Email: sales@tigerfiltration.co.uk

Tiger Filtration Ltd

Becker

Alternative filter elements manufactured for **Tiger Filtration Ltd** to fit into **Becker** vacuum pumps

Alternative Filter Elements



Tiger P/No.	Becker P/No.	List Price £
BK100 MF	6540100	47.00
BK402 MF	965402	70.00
BK403 MF	965403	55.00
BK404 MF	965404	56.00
BK406 MF	965406	56.00
BK409 MF	965409	97.00
BK410 MF	965410	180.00
BK411 MF	965411	207.00
BK412 MF	965412	103.00
BK414 MF	965414	62.00
BK415 MF	965415	103.00
BK416 MF	965416	103.00



Tiger Filtration Ltd

Units 4a & 4b, East Way, Rivergreen Industry Centre, Pallion, Sunderland, SR4 6AD, UK

Tel: +44 (0) 191 565 5348 Fax: +44 (0) 191 564 0002 Email: sales@tigerfiltration.co.uk

Tiger Filtration Ltd

Alternative Filter Elements

BOGE

Alternative filter elements manufactured by **Tiger Filtration Ltd** to fit into **BOGE** filter housings



Tiger P/No.	BOGE P/No.	List Price £
BG5 (*)	1/5 (*)	57.00
BG10 (*)	1/10 (*)	69.00
BG12 (*)	1/12 (*)	80.00
BG20 (*)	1/20 (*)	99.00
BG30 (*)	1/30 (*)	130.00
BG50 (*)	1/50 (*)	167.00
BG80 (*)	1/80 (*)	208.00
BG120 (*)	1/120 (*)	268.00
BG160 (*)	1/160 (*)	316.00
BG250 (*)	1/250 (*)	369.00
BG400 (*)	1/400 (*)	613.00

(*) = grade - Example: 1/5 V order as BG5 M3

M3 replaces V (3 Micron)

MX replaces FP (0.01 Micron)

AC replaces A (Activated Carbon)



Tiger Filtration Ltd

Units 4a & 4b, East Way, Rivergreen Industry Centre, Pallion, Sunderland, SR4 6AD, UK

Tel: +44 (0) 191 565 5348 Fax: +44 (0) 191 564 0002 Email: sales@tigerfiltration.co.uk

Tiger Filtration Ltd

Alternative Filter Elements

Busch

Alternative filter elements manufactured by **Tiger Filtration Ltd** to fit into **Busch** vacuum pumps



Grade MF			Without Silencer
Tiger P/No.	Busch P/No.	O. D. Length	List Price £
BU216 MF	532-216	54mm/120mm	25.00
BU222 MF	532-222	54mm/200mm	25.00
BU221 MF	532-221	72mm/130mm	25.00
BU302 MF	532-302	72mm/250mm	31.00
BU303 MF	532-303	72mm/375mm	48.00
BU304 MF	532-304	72mm/500mm	63.00

Grade MFS			With Silencer
Tiger P/No.	Busch P/No.	O. D. Length	List Price £
BU510 MFS	532-510	72mm/130mm	30.00
BU509 MFS	532-509	72mm/250mm	36.00
BU508 MFS	532-508	72mm/375mm	53.00
BU507 MFS	532-507	72mm/500mm	69.00
BU512 MFS	532-512	72mm/208mm	33.00

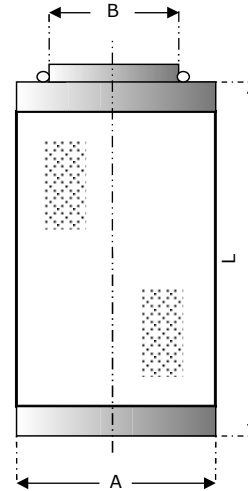

Tiger P/No.	A (mm)	B (mm)	L (mm)
BU216 MF	54	29	120
BU222 MF	54	29	200
BU221 MF	72	35	130
BU302 MF	72	35	250
BU303 MF	72	35	375
BU304 MF	72	35	500
BU510 MFS	72	35	130
BU509 MFS	72	35	250
BU508 MFS	72	35	375
BU507 MFS	72	35	500
BU512 MFS	72	35	208



Tiger Filtration Ltd

Units 4a & 4b, East Way, Rivergreen Industry Centre, Pallion, Sunderland, SR4 6AD, UK

Tel: +44 (0) 191 565 5348 Fax: +44 (0) 191 564 0002 Email: sales@tigerfiltration.co.uk

Tiger Filtration Ltd

Alternative Filter Elements

Ceccato

Alternative filter elements manufactured by **Tiger Filtration Ltd** to fit into **Ceccato** filter housings



Tiger P/No.	Ceccato P/No.	List Price £
CE10 (*)	10 (*)	33.00
CE13 (*)	13 (*)	41.00
CE20 (*)	20 (*)	50.00
CE33 (*)	33 (*)	63.00
CE60 (*)	60 (*)	86.00
CE85 (*)	85 (*)	104.00
CE130 (*)	130 (*)	131.00
CE170 (*)	170 (*)	161.00
CE250 (*)	250 (*)	183.00
CE400 (*)	400 (*)	263.00

(*) = grade - Example: 10FPRE order as CE10 M1

M3 replaces FPRO (3 Micron)

M1 replaces FPRE (1 Micron)

M0 replaces FMO (0.1 Micron)

MX replaces FMM (0.01 Micron)

AC replaces FCA (Activated Carbon)



Tiger Filtration Ltd

Units 4a & 4b, East Way, Rivergreen Industry Centre, Pallion, Sunderland, SR4 6AD, UK

Tel: +44 (0) 191 565 5348 Fax: +44 (0) 191 564 0002 Email: sales@tigerfiltration.co.uk

Tiger Filtration Ltd

Alternative Filter Elements

Compair

Alternative filter elements manufactured by **Tiger Filtration Ltd** to fit into **Compair** filter housings



Tiger P/No.	Compair P/No.	List Price £
CP0005 (*)	CE0005 (*)	41.00
CP0010 (*)	CE0010 (*)	63.00
CP0018 (*)	CE0018 (*)	74.00
CP0036 (*)	CE0036 (*)	97.00
CP0087 (*)	CE0087 (*)	124.00
CP0132 (*)	CE0132 (*)	141.00
CP0198 (*)	CE0198 (*)	192.00
CP0258 (*)	CE0258 (*)	258.00
CP0372 (*)	CE0372 (*)	326.00

(*) = grade - Example: CE0005 B order as CP0005 M1

M25 replaces A (25 Micron)

M1 replaces B & E (1 Micron)

MX replaces C (0.01 Micron)

AC replaces D (Activated Carbon) - Single Stage Filter Housing

Grade ACC

Activated Carbon

Tiger P/No.	Compair P/No.	List Price £
CP0004 ACC	CE0004 D	30.00
CP0008 ACC	CE0008 D	33.00
CP0015 ACC	CE0015 D	45.00
CP0024 ACC	CE0024 D	62.00
CP0039 ACC	CE0039 D	109.00
CP0051 ACC	CE0051 D	137.00

ACC = AC Element For Duplex Housing



Tiger Filtration Ltd

Units 4a & 4b, East Way, Rivergreen Industry Centre, Pallion, Sunderland, SR4 6AD, UK

Tel: +44 (0) 191 565 5348 Fax: +44 (0) 191 564 0002 Email: sales@tigerfiltration.co.uk

Tiger Filtration Ltd

Alternative Filter Elements

Compair - Previous

Alternative filter elements manufactured by **Tiger Filtration Ltd** to fit into **Compair** filter housings



Grade M1(GPP)		1 Micron	
Tiger P/No.	Comp P/No.	List Price	£
CP21 M1	98245/121	36.00	
CP22 M1	98245/122	59.00	
CP23 M1	98245/123	69.00	
CP25 M1	98245/125	85.00	
CP26 M1	98245/126	112.00	
CP27 M1	98245/127	134.00	
CP28 M1	98245/128	192.00	
CP29 M1	98245/129	307.00	
CP30 M1	98245/130	227.00	

Grade MX(OFP)		0.01 Micron	
Tiger P/No.	Comp P/No.	List Price	£
CP41 MX	98245/141	36.00	
CP42 MX	98245/142	59.00	
CP43 MX	98245/143	69.00	
CP45 MX	98245/145	85.00	
CP46 MX	98245/146	112.00	
CP47 MX	98245/147	134.00	
CP48 MX	98245/148	192.00	
CP49 MX	98245/149	307.00	
CP50 MX	98245/150	227.00	

Grade AC(OVR)		Activated Carbon	
Tiger P/No.	Comp P/No.	List Price	£
CP61 ACC	98245/161	30.00	
CP62 ACC	98245/162	33.00	
CP63 ACC	98245/163	45.00	
CP64 ACC	98245/164	109.00	
CP65 ACC	98245/165	62.00	
CP66 ACC	98245/166	137.00	
CP67 AC	98245/167	134.00	
CP68 AC	98245/168	192.00	
CP69 AC	98245/169	307.00	
CP70 AC	98245/170	227.00	

Grade M1(GPP)		1 Micron	
Tiger P/No.	Comp P/No.	List Price	£
CP22 M1	98245/21	59.00	
CP23 M1	98245/22	69.00	
CP25 M1	98245/23	85.00	
CP26 M1	98245/25	112.00	
CP27 M1	98245/27	134.00	
CP28 M1	98245/28	192.00	
CP29 M1	98245/29	307.00	

Grade MX(OFP)		0.01 Micron	
Tiger P/No.	Comp P/No.	List Price	£
CP42 MX	98245/41	59.00	
CP43 MX	98245/42	69.00	
CP45 MX	98245/43	85.00	
CP46 MX	98245/45	112.00	
CP47 MX	98245/47	134.00	
CP48 MX	98245/48	192.00	
CP49 MX	98245/49	307.00	

Grade AC(OVR)		Activated Carbon	
Tiger P/No.	Comp P/No.	List Price	£
CP62 ACC	98245/62	33.00	
CP65 ACC	98245/65	62.00	
CP67 AC	98245/67	134.00	
CP68 AC	98245/68	192.00	

ACC = AC Element For Duplex Housing



Tiger Filtration Ltd

Units 4a & 4b, East Way, Rivergreen Industry Centre, Pallion, Sunderland, SR4 6AD, UK

Tel: +44 (0) 191 565 5348 Fax: +44 (0) 191 564 0002 Email: sales@tigerfiltration.co.uk

Tiger Filtration Ltd

Alternative Filter Elements

C.T.A.

Alternative filter elements manufactured by **Tiger Filtration Ltd** to fit into **C.T.A.** filter housings



Tiger P/No.	CTA P/No.	List Price £
CT5050 (*)	05050 (*)	32.00
CT6050 (*)	06050 (*)	37.00
CT7050 (*)	07050 (*)	43.00
CT14050 (*)	14050 (*)	53.00
CT12075 (*)	12075 (*)	69.00
CT22075 (*)	22075 (*)	88.00
CT32075 (*)	32075 (*)	110.00
CT50075 (*)	50075 (*)	140.00
CT51090 (*)	51090 (*)	170.00
CT76090 (*)	76090 (*)	196.00
CT75140 (*)	75140 (*)	277.00

(*) = grade - Example: 05050 M order as CT5050 M1

M3 replaces P (3 Micron)

M1 replaces M (1 Micron)

MX replaces S (0.01 Micron)

AC replaces A (Activated Carbon)

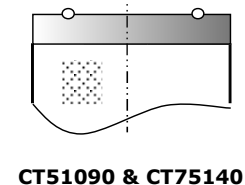
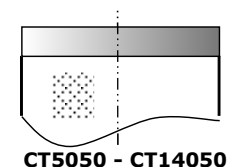
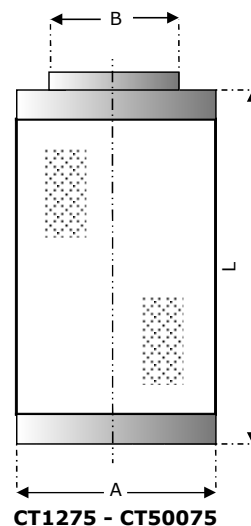

Tiger P/No.	A (mm)	B (mm)	L (mm)
CT5050 (*)	51	n/a	50
CT6050 (*)	51	n/a	61
CT7050 (*)	51	n/a	72
CT14050 (*)	51	n/a	140
CT12075 (*)	75	63	119
CT22075 (*)	75	63	219
CT32075 (*)	75	63	319
CT50075 (*)	75	63	500
CT51090 (*)	91	n/a	509
CT76090 (*)	91	n/a	766
CT75140 (*)	140	n/a	751



Tiger Filtration Ltd

Units 4a & 4b, East Way, Rivergreen Industry Centre, Pallion, Sunderland, SR4 6AD, UK

Tel: +44 (0) 191 565 5348 Fax: +44 (0) 191 564 0002 Email: sales@tigerfiltration.co.uk

Tiger Filtration Ltd

Alternative Filter Elements

Deltech

Alternative filter elements manufactured for **Tiger Filtration Ltd** to fit into **Deltech** filter housings



Tiger P/No.	Deltech P/No.	List Price £
DE9 (*)	(*) D 9	P.O.A.
DE18 (*)	(*) D 18	P.O.A.
DE36 (*)	(*) D 36	P.O.A.
DE54 (*)	(*) D 54	P.O.A.
DE90 (*)	(*) D 90	P.O.A.
DE135 (*)	(*) D 135	P.O.A.
DE216 (*)	(*) D 216	P.O.A.
DE285 (*)	(*) D 285	P.O.A.
DE405 (*)	(*) D 405	P.O.A.
DE540 (*)	(*) D 540	P.O.A.
DE750 (*)	(*) D 750	P.O.A.

(*) = grade - Example: PFD 9 order as DE9 M1

M1 replaces PF & DF (1 Micron)

MX replaces HF (0.01 Micron & 0.01mg/m³ oil removal)

AC replaces CF (Activated Carbon)



Tiger Filtration Ltd

Units 4a & 4b, East Way, Rivergreen Industry Centre, Pallion, Sunderland, SR4 6AD UK

Tel: +44 (0) 191 565 5348 Fax: +44 (0) 191 564 0002 Email: sales@tigerfiltration.co.uk

Tiger Filtration Ltd

Alternative Filter Elements

Domnick Hunter (Parker)

Alternative filter elements manufactured by **Tiger Filtration Ltd** to fit into **Domnick Hunter (Parker)** filter housings



Tiger P/No.	DH P/No.	List Price £
DH009 (*)	K009 (*)	36.00
DH017 (*)	K017 (*)	59.00
DH030 (*)	K030 (*)	69.00
DH058 (*)	K058 (*)	85.00
DH145 (*)	K145 (*)	112.00
DH220 (*)	K220 (*)	134.00
DH330 (*)	K330 (*)	192.00
DH430 (*)	K430 (*)	227.00
DH620 (*)	K620 (*)	307.00

(*) = grade - Example: K009 AO order as DH009 M1

M25 replaces PF (25 Micron)

M1 replaces AO (1 Micron)

MX replaces AA (0.01 Micron & 0.01mg/m³ oil removal)

MXX replaces AX (0.01 Micron & 0.001mg/m³ oil removal)

AC replaces ACS (Activated Carbon) - Single Stage Filter Housing

Grade ACC

Activated Carbon

Tiger P/No.	DH P/No.	List Price £
DH006 ACC	K006 AC	30.00
DH013 ACC	K013 AC	33.00
DH025 ACC	K025 AC	45.00
DH040 ACC	K040 AC	62.00
DH065 ACC	K065 AC	109.00
DH085 ACC	K085 AC	137.00

ACC = AC Element For Duplex Housing



Tiger Filtration Ltd

Units 4a & 4b, East Way, Rivergreen Industry Centre, Pallion, Sunderland, SR4 6AD, UK

Tel: +44 (0) 191 565 5348 Fax: +44 (0) 191 564 0002 Email: sales@tigerfiltration.co.uk

Tiger Filtration Ltd

Alternative Filter Elements

Domnick Hunter (Parker) - Previous

Alternative filter elements manufactured by **Tiger Filtration Ltd** to fit into **Domnick Hunter (Parker)** filter housings



Tiger P/No.	DH P/No.	List Price £
DH006 (*)	K006 (*)	36.00
DH013 (*)	K013 (*)	59.00
DH025 (*)	K025 (*)	69.00
DH040 (*)	K040 (*)	85.00
DH085 (*)	K085 (*)	112.00
DH195 (*)	K195 (*)	134.00
DH295 (*)	K295 (*)	192.00
DH400 (*)	K400 (*)	227.00
DH500 (*)	K500 (*)	307.00

(*) = grade - Example: K006 AO order as DH006 M1

M25 replaces PF (25 Micron)

M1 replaces AO (1 Micron)

MX replaces AA (0.01 Micron & 0.01mg/m³ oil removal)

MXX replaces AX (0.01 Micron & 0.001mg/m³ oil removal)

AC replaces ACS with the exception of K006 AC which is replaced by DH006 ACC



Tiger Filtration Ltd

Units 4a & 4b, East Way, Rivergreen Industry Centre, Pallion, Sunderland, SR4 6AD, UK

Tel: +44 (0) 191 565 5348 Fax: +44 (0) 191 564 0002 Email: sales@tigerfiltration.co.uk

Tiger Filtration Ltd

Alternative Filter Elements

Domnick Hunter (Parker) - Previous

Alternative filter elements manufactured by **Tiger Filtration Ltd** to fit into **Domnick Hunter (Parker)** filter housings



Tiger P/No.	DH P/No.	List Price £
DH007 (*)	E007 (*)	59.00
DH011 (*)	E011 (*)	69.00
DH035 (*)	E035 (*)	85.00
DH060 (*)	E060 (*)	112.00
DH120 (*)	E120 (*)	134.00
DH200 (*)	E200 (*)	192.00
DH250 (*)	E250 (*)	192.00
DH300 (*)	E300 (*)	307.00
DH360 (*)	E360 (*)	307.00

(*) = grade - Example: E007 AO order as DH007 M1

M25 replaces PF (25 Micron)

M1 replaces AO (1 Micron)

MX replaces AA (0.01 Micron & 0.01mg/m³ oil removal)

Tiger P/No.	DH P/No.	List Price £
DH007 (*)	E007 (*)	59.00
DH011 (*)	E011 (*)	69.00
DH035 (*)	E035 (*)	85.00
DH060 (*)	E060 (*)	112.00
DH085 (*)	E085 (*)	112.00
DH120 (*)	E120 (*)	134.00
DH195 (*)	E195 (*)	134.00
DH200 (*)	E200 (*)	192.00
DH250 (*)	E250 (*)	192.00
DH295 (*)	E295 (*)	192.00
DH300 (*)	E300 (*)	307.00
DH360 (*)	E360 (*)	307.00
DH500 (*)	E500 (*)	307.00

(*) = grade - Example: E007 AOTS order as DH007 M1

M1 replaces AOTS (1 Micron)

MX replaces AATS (0.01 Micron)

Grade AC		Activated Carbon
Tiger P/No.	DH P/No.	List Price £
DH011 ACC	ABN 1	44.00
DH011 ACC	E011 AC	44.00
DH060 ACC	E060 AC	62.00
DH120 AC	E120 AC	134.00
DH200 AC	E200 AC	192.00
DH250 AC	E250 AC	192.00
DH300 AC	E300 AC	307.00
DH360 AC	E360 AC	307.00

ACC = AC Element For Duplex Housing



Tiger Filtration Ltd

Units 4a & 4b, East Way, Rivergreen Industry Centre, Pallion, Sunderland, SR4 6AD, UK

Tel: +44 (0) 191 565 5348 Fax: +44 (0) 191 564 0002 Email: sales@tigerfiltration.co.uk

Tiger Filtration Ltd

Alternative Filter Elements

Edwards

Alternative air/oil separator elements manufactured by **Tiger Filtration Ltd** to fit into **Edwards** vacuum pumps



Tiger P/No.	Edwards P/No.	List Price £
ED 057	A223 04 057	70.00
ED 020	A223 04 020	79.00
ED 021	A223 04 021	89.00

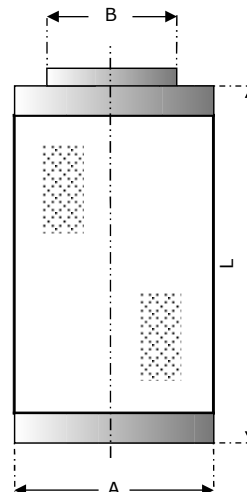

Tiger P/No.	A (mm)	B (mm)	L (mm)
ED057	80	31	173
ED020	80	31	252
ED021	80	55	380



Tiger Filtration Ltd

Units 4a & 4b, East Way, Rivergreen Industry Centre, Pallion, Sunderland, SR4 6AD, UK

Tel: +44 (0) 191 565 5348 Fax: +44 (0) 191 564 0002 Email: sales@tigerfiltration.co.uk

Tiger Filtration Ltd

Alternative Filter Elements

Friulair

Alternative filter elements manufactured by **Tiger Filtration Ltd** to fit into **Friulair** filter housings



Tiger P/No.	Friulair P/No.	List Price £
FT008 (*)	T (*) 008	27.00
FT012 (*)	T (*) 012	32.00
FT018 (*)	T (*) 018	40.00
FT030 (*)	T (*) 030	50.00
FT055 (*)	T (*) 055	68.00
FT080 (*)	T (*) 080	81.00
FT120 (*)	T (*) 120	102.00
FT160 (*)	T (*) 160	145.00
FT220 (*)	T (*) 220	218.00
FT250 (*)	T (*) 250	174.00
FT400 (*)	T (*) 400	227.00

(*) = grade - Example: TS008 order as FT008 M1
 M5 replaces P (5 Micron)
 M1 replaces S (1 Micron)
 MX replaces X (0.01 Micron & 0.01mg/m³ oil removal)
 AC replaces Z (Activated Carbon)

N.B. The FT220 (*) element is for multi-candle fabricated vessels

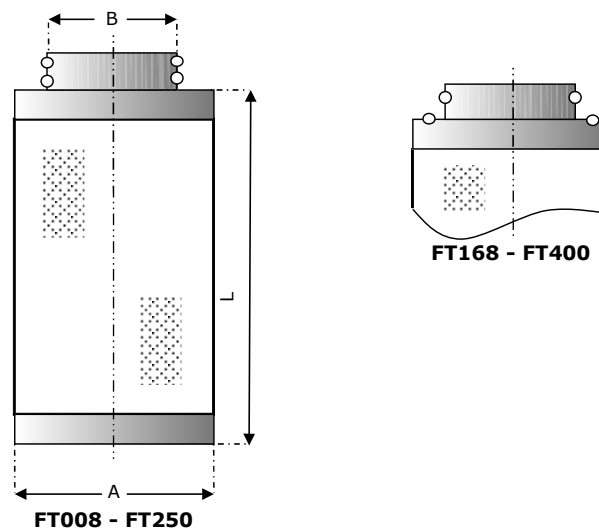

Tiger P/No.	A (mm)	B (mm)	L (mm)
FT008	51	23	61
FT012	51	23	72
FT018	51	23	140
FT030	75	45	119
FT055	75	45	219
FT080	75	45	319
FT120	75	45	497
FT160	91	71	509
FT220	91	71	680
FT250	91	71	766
FT400	140	102	751



Tiger Filtration Ltd

Units 4a & 4b, East Way, Rivergreen Industry Centre, Pallion, Sunderland, SR4 6AD, UK

Tel: +44 (0) 191 565 5348 Fax: +44 (0) 191 564 0002 Email: sales@tigerfiltration.co.uk

Tiger Filtration Ltd

Alternative Filter Elements

Frulair - Previous

Alternative filter elements manufactured by **Tiger Filtration Ltd** to fit into **Frulair** filter housings



Tiger P/No.	Frulair P/No.	List Price £
FL008 (*)	L (*) 008	27.00
FL011 (*)	L (*) 011	32.00
FL018 (*)	L (*) 018	40.00
FL031 (*)	L (*) 031	50.00
FL052 (*)	L (*) 052	68.00
FL075 (*)	L (*) 075	81.00
FL118 (*)	L (*) 118	102.00
FL168 (*)	L (*) 168	145.00
FL250 (*)	L (*) 250	174.00
FL400 (*)	L (*) 400	227.00

(*) = grade - Example: LS008 order as FL008 M1
 M5 replaces P (5 Micron)
 M1 replaces S (1 Micron)
 MX replaces X (0.01 Micron & 0.01mg/m³ oil removal)
 AC replaces Z (Activated Carbon)

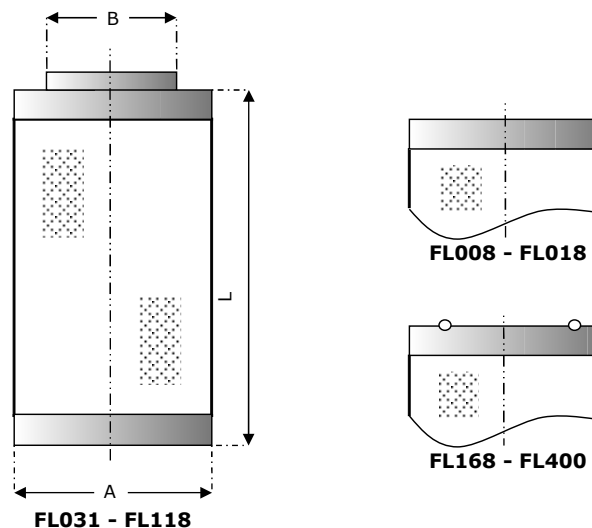

Tiger P/No.	A (mm)	B (mm)	L (mm)
FL008	51	n/a	61
FL011	51	n/a	72
FL018	51	n/a	140
FL031	75	63	119
FL052	75	63	219
FL075	75	63	319
FL118	75	63	497
FL168	91	n/a	509
FL250	91	n/a	766
FL400	140	n/a	751



Tiger Filtration Ltd
 Units 4a & 4b, East Way, Rivergreen Industry Centre, Pallion, Sunderland, SR4 6AD, UK
 Tel: +44 (0) 191 565 5348 Fax: +44 (0) 191 564 0002 Email: sales@tigerfiltration.co.uk

Tiger Filtration Ltd

Alternative Filter Elements

Hankison

Alternative filter elements manufactured by **Tiger Filtration Ltd** to fit into **Hankison** filter housings



Tiger P/No.	Hankison P/No.	List Price £
HK12 (*)	E (*) -12	42.00
HK16 (*)	E (*) - 16	56.00
HK20 (*)	E (*) - 20	74.00
HK24 (*)	E (*) - 24	92.00
HK28 (*)	E (*) - 28	114.00
HK32 (*)	E (*) - 32	129.00
HK36 (*)	E (*) - 36	162.00
HK40 (*)	E (*) - 40	189.00
HK44 (*)	E (*) - 44	215.00
HK52PV (*)	E (*) - 52PV	231.00
HK48 (*)	E (*) - 48	223.00
HK54 (*)	E (*) - 54	223.00

(*) = grade - Example: E7-12 order as HK12 M1

M5 replaces 9 (5 Micron)

M1 replaces 7 (1 Micron)

MX replaces 5 (0.01 Micron & 0.01mg/m³ oil removal)

MXX replaces 3 (0.01 Micron & 0.001mg/m³ oil removal)

AC replaces 1 (Activated Carbon)

N.B. The HK52PV (*) is for multi-candle fabricated vessels



Tiger Filtration Ltd

Units 4a & 4b, East Way, Rivergreen Industry Centre, Pallion, Sunderland, SR4 6AD, UK

Tel: +44 (0) 191 565 5348 Fax: +44 (0) 191 564 0002 Email: sales@tigerfiltration.co.uk

Tiger Filtration Ltd

Alternative Filter Elements

Hiross (Parker)

Alternative filter elements manufactured by **Tiger Filtration Ltd** to fit into **Hiross (Parker)** filter housings



Tiger P/No.	Hiross P/No.	List Price £
HR005 (*)	005 (*)	40.00
HR010 (*)	002 (*) - 004 (*) - 006 (*) - 010 (*)	40.00
HR016 (*)	007 (*) - 009 (*) - 016 (*)	50.00
HR022 (*)	(*) - 015 (*) - 018 (*) - 020 (*) - 022 (*)	57.00
HR030 (*)	024 (*) - 030 (*)	60.00
HR045 (*)	035 (*) - 045 (*)	66.00
HR072 (*)	060 (*) - 062 (*) - 072 (*)	84.00
HR135 (*)	090 (*) - 110 (*) - 122 (*) - 135 (*)	115.00
HR175 (*)	175 (*)	131.00
HR205 (*)	120 (*) - 151 (*) - 205 (*)	148.00
HR180 (*)	150 (*) - 180 (*)	161.00
HR250 (*)	250 (*)	161.00
HR260 (*)	260 (*)	229.00
HR280 (*)	240 (*) - 280 (*)	242.00
HR300 (*)	300 (*)	206.00
HR370 (*)	370 (*)	286.00

(*) = grade - Example: 005P order as HR005 M1

M5 replaces Q (5 Micron)

M1 replaces P (1 Micron)

MX replaces S (0.01 Micron)

AC replaces C (Activated Carbon)

N.B. The HR250 element is for fabricated housing with multiple elements and will be supplied with a 13.5mm dia through hole.



Tiger Filtration Ltd

Units 4a & 4b, East Way, Rivergreen Industry Centre, Pallion, Sunderland, SR4 6AD, UK

Tel: +44 (0) 191 565 5348 Fax: +44 (0) 191 564 0002 Email: sales@tigerfiltration.co.uk

Tiger Filtration Ltd

HPC

Alternative filter elements manufactured by **Tiger Filtration Ltd** to fit into **HPC** filter housings

Tiger P/No.	HPC P/No.	List Price £
HP009 (*)	K009 (*)	36.00
HP017 (*)	K017 (*)	59.00
HP030 (*)	K030 (*)	69.00
HP058 (*)	K058 (*)	85.00
HP145 (*)	K145 (*)	112.00
HP220 (*)	K220 (*)	134.00
HP330 (*)	K330 (*)	192.00
HP430 (*)	K430 (*)	227.00
HP620 (*)	K620 (*)	307.00

(*) = grade - Example: K009 AO order as HP009 M1
 M1 replaces AO (1 Micron)
 MX replaces AA (0.01 Micron & 0.01mg/m³ oil removal)

Tiger P/No.	HPC P/No.	List Price £
HP006 (*)	K006 (*)	36.00
HP013 (*)	K013 (*)	59.00
HP025 (*)	K025 (*)	69.00
HP040 (*)	K040 (*)	85.00
HP085 (*)	K085 (*)	112.00
HP195 (*)	K195 (*)	134.00
HP295 (*)	K295 (*)	192.00
HP400 (*)	K400 (*)	227.00
HP500 (*)	K500 (*)	307.00

(*) = grade - Example: K006 AO order as HP006 M1
 M1 replaces AO (1 Micron)
 MX replaces AA (0.01 Micron & 0.01mg/m³ oil removal)

Alternative Filter Elements



Grade AC		Activated Carbon	
Tiger P/No.	HPC P/No.	Tiger P/No.	HPC P/No.
HP006 ACC	K006 AC	HP006 ACC	K006 AC
HP013 ACC	K013 AC	HP013 ACC	K013 AC
HP025 ACC	K025 AC	HP025 ACC	K025 AC
HP040 ACC	K040 AC	HP040 ACC	K040 AC
HP065 ACC	K065 AC	HP065 ACC	K065 AC
HP085 ACC	K085 AC	HP085 ACC	K085 AC
HP195 AC	K195 AC	HP195 AC	K195 AC
HP295 AC	K295 AC	HP295 AC	K295 AC
HP400 AC	K400 AC	HP400 AC	K400 AC
HP500 AC	K500 AC	HP500 AC	K500 AC

ACC = AC Element For Duplex Housing



Tiger Filtration Ltd

Units 4a & 4b, East Way, Rivergreen Industry Centre, Pallion, Sunderland, SR4 6AD, UK

Tel: +44 (0) 191 565 5348 Fax: +44 (0) 191 564 0002 Email: sales@tigerfiltration.co.uk

Tiger Filtration Ltd

Alternative Filter Elements

Hydrovane

Alternative filter elements manufactured by **Tiger Filtration Ltd** to fit into **Hydrovane** filter housings



Tiger P/No.	Hydro P/No.	List Price £
HY100 (*)	(*) 100 E	36.00
HY150 (*)	(*) 150 E	59.00
HY200 (*)	(*) 200 E	69.00
HY250 (*)	(*) 250 E	85.00
HY350 (*)	(*) 350 E	112.00
HY450 (*)	(*) 450 E	134.00
HY500 (*)	(*) 500 E	192.00
HY530 (*)	(*) 530 E	227.00
HY600 (*)	(*) 600 E	307.00

(*) = grade - Example: GP100 E order as HY100 M1

M1 replaces GP & DR (1 Micron)

MX replaces HE (0.01 Micron & 0.01mg/m³ oil removal)

Grade AC

Activated Carbon

Tiger P/No.	Hydro P/No.	List Price £
HY100 ACC	OR100 E	30.00
HY150 ACC	OR150 E	33.00
HY200 ACC	OR200 E	45.00
HY250 ACC	OR250 E	62.00
HY300 ACC	OR300 E	109.00
HY350 ACC	OR350 E	137.00
HY450 AC	OR450 E	134.00
HY500 AC	OR500 E	192.00
HY530 AC	OR530 E	227.00
HY600 AC	OR600 E	307.00

ACC = Activated Carbon Element For Duplex Housing



Tiger Filtration Ltd

Units 4a & 4b, East Way, Rivergreen Industry Centre, Pallion, Sunderland, SR4 6AD, UK

Tel: +44 (0) 191 565 5348 Fax: +44 (0) 191 564 0002 Email: sales@tigerfiltration.co.uk

Tiger Filtration Ltd

Alternative Filter Elements

Hydrovane

Alternative air/oil separator elements manufactured by **Tiger Filtration Ltd** to fit into **Hydrovane** air compressors



Tiger P/No.	Hydro P/No.	List Price £
HY52022	52022	30.00
HY3415	3415	30.00
HY3407	3407	30.00
HY52471	52471	30.00
HY57029	57029	30.00
HY59177	59177	32.00
HY70166	70166	20.00
HY70539	70539	32.00
HY59180	59180	32.00

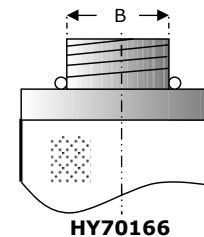
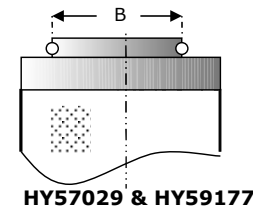
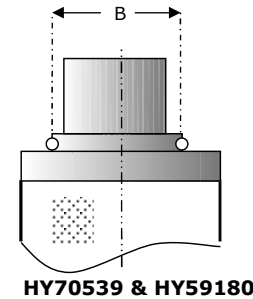
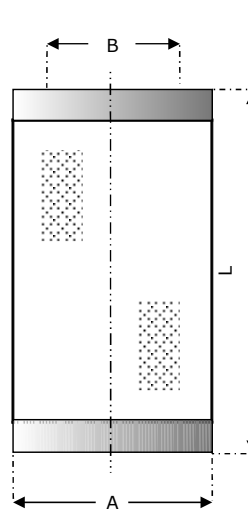

Tiger P/No.	A (mm)	B (mm)	L (mm)
HY52022	70	40 (ID)	70
HY3415	70	40 (ID)	200
HY3407	70	40 (ID)	255
HY52471	70	40 (ID)	175
HY57029	70	40	84
HY59177	70	40	204
HY70166	21.5	1/8" BSP	31
HY70539	70	40	204
HY59180	70	40	255



Tiger Filtration Ltd

Units 4a & 4b, East Way, Rivergreen Industry Centre, Pallion, Sunderland, SR4 6AD, UK

Tel: +44 (0) 191 565 5348 Fax: +44 (0) 191 564 0002 Email: sales@tigerfiltration.co.uk

Tiger Filtration Ltd

Alternative Filter Elements

Ingersoll Rand

Alternative filter elements manufactured by **Tiger Filtration Ltd** to fit into **Ingersoll Rand** filter housings



Tiger P/No.	IR P/No.	List Price £
IR5 (*)	5 (*)	36.00
IR10 (*)	10 (*)	59.00
IR18 (*)	18 (*)	69.00
IR36 (*)	36 (*)	85.00
IR48 (*)	48 (*)	112.00
IR119 (*)	119 (*)	134.00
IR198 (*)	198 (*)	192.00
IR239 (*)	239 (*)	227.00
IR372 (*)	372 (*)	307.00

Grade AC		Activated Carbon
Tiger P/No.	IR P/No.	List Price £
IR5 AC	5 ACS	36.00
IR10 AC	10 ACS	59.00
IR18 AC	18 ACS	69.00
IR36 AC	36 ACS	85.00
IR48 AC	48 ACS	112.00
IR119 AC	119 ACS	134.00
IR198 AC	198 ACS	192.00
IR239 AC	239 ACS	227.00
IR372 AC	372 ACS	307.00

(*) = grade - Example: 5 AO order as IR5 M1

M1 replaces AO & AR (1 Micron)

MX replaces AA (0.01 Micron & 0.01mg/m³ oil removal)

Tiger P/No.	IR P/No.	List Price £
IR4 (*)	E4 (*)	36.00
IR8 (*)	E8 (*)	59.00
IR15 (*)	E15 (*)	69.00
IR24 (*)	E24 (*)	85.00
IR50 (*)	E50 (*)	112.00
IR125 (*)	E125 (*)	134.00
IR180 (*)	E180 (*)	192.00
IR240 (*)	E240 (*)	227.00
IR300 (*)	E300 (*)	307.00

Grade AC		Activated Carbon
Tiger P/No.	IR P/No.	List Price £
IR4 ACC	E4 AC	30.00
IR8 ACC	E8 AC	33.00
IR15 ACC	E15 AC	45.00
IR24 ACC	E24 AC	62.00
IR39 ACC	E39 AC	109.00
IR50 ACC	E50 AC	137.00
IR125 AC	E125 AC	134.00
IR180 AC	E180 AC	192.00
IR240 AC	E240 AC	227.00
IR300 AC	E300 AC	307.00

(*) = grade - Example: E4 AO order as IR4 M1

M1 replaces AO & AR (1 Micron)

MX replaces AA (0.01 Micron & 0.01mg/m³ oil removal)



Tiger Filtration Ltd

Units 4a & 4b, East Way, Rivergreen Industry Centre, Pallion, Sunderland, SR4 6AD, UK

Tel: +44 (0) 191 565 5348 Fax: +44 (0) 191 564 0002 Email: sales@tigerfiltration.co.uk

Tiger Filtration Ltd

Alternative Filter Elements

Kaeser

Alternative filter elements manufactured by **Tiger Filtration Ltd** to fit into **Kaeser** filter housings



Tiger P/No.	Kaeser P/No.	List Price £
KS006 (*)	E - (*) - 6	42.00
KS010 (*)	E - (*) - 10	56.00
KS018 (*)	E - (*) - 18	74.00
KS028 (*)	E - (*) - 28	92.00
KS048 (*)	E - (*) - 48	114.00
KS071 (*)	E - (*) - 71	129.00
KS107 (*)	E - (*) - 107	162.00
KS138 (*)	E - (*) - 138	189.00
KS177 (*)	E - (*) - 177	215.00
KS185 (*)	E - (*) - 185	231.00
KS221 (*)	E - (*) - 221	223.00
KS283 (*)	E - (*) - 283	223.00

(*) = grade - Example: E-C-6 order as KS006 M1

M5 replaces B (5 Micron)

M1 replaces C (1 Micron)

MX replaces E (0.01 Micron & 0.01mg/m³ oil removal)

MXX replaces F (0.01 Micron & 0.001mg/m³ oil removal)

AC replaces G (Activated Carbon)

RM1 replaces D (1 micron)



Tiger Filtration Ltd

Units 4a & 4b, East Way, Rivergreen Industry Centre, Pallion, Sunderland, SR4 6AD, UK

Tel: +44 (0) 191 565 5348 Fax: +44 (0) 191 564 0002 Email: sales@tigerfiltration.co.uk

Tiger Filtration Ltd

Alternative Filter Elements

Leybold

Alternative filter elements manufactured by **Tiger Filtration Ltd** to fit into **Leybold** vacuum pumps



Tiger P/No.	Leybold P/No.	Pump Model	List Price £
LY023	712-32-023	SV16 - 25	57.00
LY763	710-64-763	SV40 - 200	68.00
LY773	710-64-773	SV280 - 1200	79.00

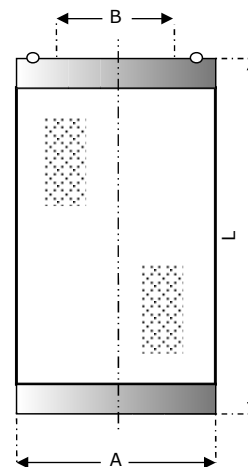

Tiger P/No.	A (mm)	B (mm)	L (mm)
LY023	55	24 (ID)	152
LY763	66	40 (ID)	228
LY773	66	40 (ID)	400



Tiger Filtration Ltd

Units 4a & 4b, East Way, Rivergreen Industry Centre, Pallion, Sunderland, SR4 6AD, UK

Tel: +44 (0) 191 565 5348 Fax: +44 (0) 191 564 0002 Email: sales@tigerfiltration.co.uk

Tiger Filtration Ltd

Alternative Filter Elements

Mark

Alternative filter elements manufactured by **Tiger Filtration Ltd** to fit into **Mark** filter housings



Tiger P/No.	Mark P/No.	List Price £
MK10 (*)	10 (*)	33.00
MK13 (*)	13 (*)	41.00
MK20 (*)	20 (*)	50.00
MK33 (*)	33 (*)	63.00
MK60 (*)	60 (*)	86.00
MK85 (*)	85 (*)	104.00
MK130 (*)	130 (*)	131.00
MK170 (*)	170 (*)	161.00
MK250 (*)	250 (*)	183.00
MK400 (*)	400 (*)	263.00

(*) = grade - Example: 10FPRE order as MK10 M1

M3 replaces FPRO (3 Micron)

M1 replaces FPPE (1 Micron)

M0 replaces FMO (0.1 Micron)

MX replaces FMM (0.01 Micron)

AC replaces FCA (Activated Carbon)



Tiger Filtration Ltd

Units 4a & 4b, East Way, Rivergreen Industry Centre, Pallion, Sunderland, SR4 6AD, UK

Tel: +44 (0) 191 565 5348 Fax: +44 (0) 191 564 0002 Email: sales@tigerfiltration.co.uk

Tiger Filtration Ltd

Alternative Filter Elements

Mattei

Alternative filter elements manufactured by **Tiger Filtration Ltd** to fit into **Mattei** filter housings



Tiger P/No.	Mattei P/No.	List Price £
MA005 (*)	04E 0030 (*)	23.00
MA010 (*)	04E 0060 (*)	27.00
MA018 (*)	04E 0108 (*)	36.00
MA030 (*)	04E 0180 (*)	38.00
MA034 (*)	04E 0204 (*)	41.00
MA050 (*)	04E 0300 (*)	48.00
MA072 (*)	04E 0432 (*)	54.00
MA095 (*)	04E 0570 (*)	72.00
MA125 (*)	04E 0750 (*)	93.00
MA165 (*)	04E 0990 (*)	113.00
MA190 (*)	04E 1140 (*)	122.00
MA220 (*)	04E 1320 (*)	160.00

(*) = grade - Example: 04E 0030 PF order as MA005 M1

M25 replaces D (25 Micron)

M5 replaces Q (5 Micron)

M1 replaces P (1 Micron)

MX replaces H (0.01 Micron & 0.01mg/m³ oil removal)

MXX replaces S (0.01 Micron & 0.001mg/m³ oil removal)

AC replaces C (Activated Carbon)



Tiger Filtration Ltd

Units 4a & 4b, East Way, Rivergreen Industry Centre, Pallion, Sunderland, SR4 6AD, UK

Tel: +44 (0) 191 565 5348 Fax: +44 (0) 191 564 0002 Email: sales@tigerfiltration.co.uk

Tiger Filtration Ltd

Alternative Filter Elements

Mattei

Alternative air/oil separator elements manufactured by **Tiger Filtration Ltd** to fit into **Mattei** air compressors



Grade M1/RM1 1 Micron

Tiger P/No.	Mattei P/No.	List Price £
MA20113	CR2201130	36.00
MA30725	CR21F30725	32.00
MA30732	CR21A30732	30.00
MA30733	CR21H30733	40.00

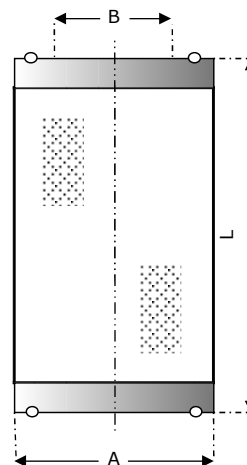

Tiger P/No.	A (mm)	B (mm)	L (mm)
MA20113	100	70 (ID)	252
MA30725	70	40 (ID)	200
MA30732	70	40 (ID)	255
MA30733	70	40 (ID)	400



Tiger Filtration Ltd

Units 4a & 4b, East Way, Rivergreen Industry Centre, Pallion, Sunderland, SR4 6AD, UK

Tel: +44 (0) 191 565 5348 Fax: +44 (0) 191 564 0002 Email: sales@tigerfiltration.co.uk

Tiger Filtration Ltd

Alternative Filter Elements

MiKROPOR

Alternative filter elements manufactured by **Tiger Filtration Ltd** to fit into **MiKROPOR** filter housings



Tiger P/No.	Mikropor P/No.	List Price £
MP24 (*)	M24 (*)	44.00
MP48 (*)	M48 (*)	44.00
MP25 (*)	M25 (*)	47.00
MP50 (*)	M50 (*)	47.00
MP100 (*)	M100 (*)	54.00
MP150 (*)	M150 (*)	63.00
MP200 (*)	M200 (*)	68.00
MP250 (*)	M250 (*)	72.00
MP300 (*)	M300 (*)	80.00
MP500 (*)	M500 (*)	88.00
MP600 (*)	M600 (*)	97.00
MP851 (*)	M851 (*)	175.00
MP1210 (*)	M1210 (*)	194.00
MP1510 (*)	M1510 (*)	224.00
MP1810 (*)	M1810 (*)	245.00
MP2210 (*)	M2210 (*)	266.00

(*) = grade - Example: M24 X order as MP24 M1
M5 replaces P (5 Micron)
M1 replaces X (1 Micron)
MX replaces Y (0.01 Micron & 0.01mg/m³ oil removal)
AC replaces A (Activated Carbon)



Tiger Filtration Ltd

Units 4a & 4b, East Way, Rivergreen Industry Centre, Pallion, Sunderland, SR4 6AD, UK

Tel: +44 (0) 191 565 5348 Fax: +44 (0) 191 564 0002 Email: sales@tigerfiltration.co.uk

Tiger Filtration Ltd

Alternative Filter Elements

M.T.A.

Alternative filter elements manufactured by **Tiger Filtration Ltd** to fit into **M.T.A.** filter housings



Tiger P/No.	MTA P/No.	List Price £
MT6050 (*)	6050 (*)	21.00
MT7050 (*)	7050 (*)	24.00
MT14050 (*)	14050 (*)	33.00
MT12075 (*)	12075 (*)	42.00
MT22075 (*)	22075 (*)	56.00
MT32075 (*)	32075 (*)	69.00
MT50075 (*)	50075 (*)	87.00
MT51090 (*)	51090 (*)	118.00
MT76090 (*)	76090 (*)	140.00
MT75140 (*)	75140 (*)	222.00

(*) = grade - Example: 6050M order as MT6050 M1
 M3 replaces P (3 Micron)
 M1 replaces M (1 Micron)
 MX replaces S (0.01 Micron & 0.01mg/m³ oil removal)
 AC replaces A (Activated Carbon)

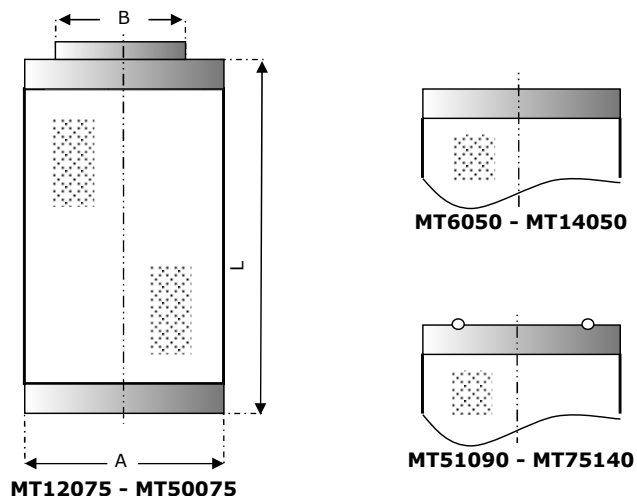

Tiger P/No.	A (mm)	B (mm)	L (mm)
MT6050	51	n/a	61
MT7050	51	n/a	72
MT14050	51	n/a	140
MT12075	75	63	119
MT22075	75	63	219
MT32075	75	63	319
MT50075	75	63	500
MT51090	92	n/a	509
MT76090	92	n/a	766
MT75140	140	n/a	751



Tiger Filtration Ltd
 Units 4a & 4b, East Way, Rivergreen Industry Centre, Pallion, Sunderland, SR4 6AD, UK
 Tel: +44 (0) 191 565 5348 Fax: +44 (0) 191 564 0002 Email: sales@tigerfiltration.co.uk

Tiger Filtration Ltd

Alternative Filter Elements

Omega

Alternative filter elements manufactured by **Tiger Filtration Ltd** to fit into **Omega** filter housings



Tiger P/No.	Omega P/No.	List Price £
OM6050 (*)	06050 (*)	33.00
OM7050 (*)	07050 (*)	41.00
OM14050 (*)	14050 (*)	50.00
OM12075 (*)	12075 (*)	63.00
OM22075 (*)	22075 (*)	86.00
OM32075 (*)	32075 (*)	104.00
OM50075 (*)	50075 (*)	131.00
OM51090 (*)	51090 (*)	161.00
OM76090 (*)	76090 (*)	183.00
OM51140 (*)	51140 (*)	231.00
OM75140 (*)	75140 (*)	263.00

(*) = grade - Example: 06050 R order as OM6050 M1
M3 replaces P (3 Micron)
M1 replaces R (1 Micron)
M0 replaces M (0.1 Micron)
MX replaces S (0.01 Micron & 0.01mg/m³ oil removal)
AC replaces A (Activated Carbon)



Tiger Filtration Ltd

Units 4a & 4b, East Way, Rivergreen Industry Centre, Pallion, Sunderland, SR4 6AD, UK

Tel: +44 (0) 191 565 5348 Fax: +44 (0) 191 564 0002 Email: sales@tigerfiltration.co.uk

Tiger Filtration Ltd

Alternative Filter Elements

OMI

Alternative filter elements manufactured by **Tiger Filtration Ltd** to fit into **OMI** filter housings



Tiger P/No.	OMI P/No.	List Price £
OM005 (*)	04E 0030 (*)	23.00
OM010 (*)	04E 0060 (*)	27.00
OM018 (*)	04E 0108 (*)	36.00
OM030 (*)	04E 0180 (*)	38.00
OM034 (*)	04E 0204 (*)	41.00
OM050 (*)	04E 0300 (*)	48.00
OM072 (*)	04E 0432 (*)	54.00
OM095 (*)	04E 0570 (*)	72.00
OM125 (*)	04E 0750 (*)	93.00
OM165 (*)	04E 0990 (*)	113.00
OM190 (*)	04E 1140 (*)	122.00
OM220 (*)	04E 1320 (*)	160.00

(*) = grade - Example: 04E 0030 PF order as OM005 M1

M10 replaces DF (10 Micron)

M5 replaces QF (5 Micron)

M1 replaces PF (1 Micron)

MX replaces HF (0.01 Micron & 0.01mg/m³ oil removal)

AC replaces CF (Activated Carbon)



Tiger Filtration Ltd

Units 4a & 4b, East Way, Rivergreen Industry Centre, Pallion, Sunderland, SR4 6AD, UK

Tel: +44 (0) 191 565 5348 Fax: +44 (0) 191 564 0002 Email: sales@tigerfiltration.co.uk

Tiger Filtration Ltd

Alternative Filter Elements

OMI-Previous

Alternative filter elements manufactured by **Tiger Filtration Ltd** to fit into **OMI** filter housings



Grade M5 (QF)		5 Micron
Tiger P/No.	OMI P/No.	List Price £
OM005 M5	040 F050	23.00
OM010 M5	040 F051	27.00
OM018 M5	040 F052	36.00
OM034 M5	040 F053	41.00
OM050 M5	040 F054	48.00
OM095 M5	040 F055	72.00
OM125 M5	040 F056	93.00
OM125 M5	040 F057	93.00
OM165 M5	040 F058	113.00
OM220 M5	040 F059	160.00

Grade M1 (PF)		1 Micron
Tiger P/No.	OMI P/No.	List Price £
OM005 M1	041 F150	23.00
OM010 M1	041 F151	27.00
OM018 M1	041 F152	36.00
OM034 M1	041 F153	41.00
OM050 M1	041 F154	48.00
OM095 M1	041 F155	72.00
OM125 M1	041 F156	93.00
OM125 M1	041 F157	93.00
OM165 M1	041 F158	113.00
OM220 M1	041 F159	160.00

Grade M0 (HF)		0.1 Micron
Tiger P/No.	OMI P/No.	List Price £
OM005 M0	042 F250	23.00
OM010 M0	042 F251	27.00
OM018 M0	042 F252	36.00
OM034 M0	042 F253	41.00
OM050 M0	042 F254	48.00
OM095 M0	042 F255	72.00
OM125 M0	042 F256	93.00
OM125 M0	042 F257	93.00
OM165 M0	042 F258	113.00
OM220 M0	042 F259	160.00

Grade AC (CF)		Activated Carbon
Tiger P/No.	OMI P/No.	List Price £
OM005 AC	043 F350	23.00
OM010 AC	043 F351	27.00
OM018 AC	043 F352	36.00
OM034 AC	043 F353	41.00
OM050 AC	043 F354	48.00
OM095 AC	043 F355	72.00
OM125 AC	043 F356	93.00
OM125 AC	043 F357	93.00
OM165 AC	043 F358	113.00
OM220 AC	043 F359	160.00



Tiger Filtration Ltd

Units 4a & 4b, East Way, Rivergreen Industry Centre, Pallion, Sunderland, SR4 6AD, UK

Tel: +44 (0) 191 565 5348 Fax: +44 (0) 191 564 0002 Email: sales@tigerfiltration.co.uk

Tiger Filtration Ltd

Pneumatech

Alternative filter elements manufactured by **Tiger Filtration Ltd** to fit into **Pneumatech** filter housings

Alternative Filter Elements



Grade M3 3 Micron

Tiger P/No.	Pn-tech P/No.	List Price £
PT01 M3	1624-5000-01	33.00
PT06 M3	1624-5000-06	41.00
PT11 M3	1624-5000-11	50.00
PT16 M3	1624-5000-16	63.00
PT21 M3	1624-5000-21	86.00
PT26 M3	1624-5000-26	104.00
PT31 M3	1624-5000-31	131.00
PT36 M3	1624-5000-36	161.00
PT41 M3	1624-5000-41	183.00
PT46 M3	1624-5000-46	231.00
PT51 M3	1624-5000-51	263.00

Grade M1 1 Micron

Tiger P/No.	Pn-tech P/No.	List Price £
PT05 M1	1624-5000-05	33.00
PT10 M1	1624-5000-10	41.00
PT15 M1	1624-5000-15	50.00
PT20 M1	1624-5000-20	63.00
PT25 M1	1624-5000-25	86.00
PT30 M1	1624-5000-30	104.00
PT35 M1	1624-5000-35	131.00
PT40 M1	1624-5000-40	161.00
PT45 M1	1624-5000-45	183.00
PT50 M1	1624-5000-50	231.00
PT55 M1	1624-5000-55	263.00

Grade M0 0.1 Micron

Tiger P/No.	Pn-tech P/No.	List Price £
PT04 M0	1624-5000-04	33.00
PT09 M0	1624-5000-09	41.00
PT14 M0	1624-5000-14	50.00
PT19 M0	1624-5000-19	63.00
PT24 M0	1624-5000-24	86.00
PT29 M0	1624-5000-29	104.00
PT34 M0	1624-5000-34	131.00
PT39 M0	1624-5000-39	161.00
PT44 M0	1624-5000-44	183.00
PT49 M0	1624-5000-49	231.00
PT54 M0	1624-5000-54	263.00

Grade MX 0.01 Micron

Tiger P/No.	Pn-tech P/No.	List Price £
PT02 MX	1624-5000-02	33.00
PT07 MX	1624-5000-07	41.00
PT12 MX	1624-5000-12	50.00
PT17 MX	1624-5000-17	63.00
PT22 MX	1624-5000-22	86.00
PT27 MX	1624-5000-27	104.00
PT32 MX	1624-5000-32	131.00
PT37 MX	1624-5000-37	161.00
PT42 MX	1624-5000-42	183.00
PT47 MX	1624-5000-47	231.00
PT52 MX	1624-5000-52	263.00

Grade AC Activated Carbon

Tiger P/No.	Pn-tech P/No.	List Price £
PT03 AC	1624-5000-03	33.00
PT08 AC	1624-5000-08	41.00
PT13 AC	1624-5000-13	50.00
PT18 AC	1624-5000-18	63.00
PT23 AC	1624-5000-23	86.00
PT28 AC	1624-5000-28	104.00
PT33 AC	1624-5000-33	131.00
PT38 AC	1624-5000-38	161.00
PT43 AC	1624-5000-43	183.00
PT48 AC	1624-5000-48	231.00
PT53 AC	1624-5000-53	263.00



Tiger Filtration Ltd

Units 4a & 4b, East Way, Rivergreen Industry Centre, Pallion, Sunderland, SR4 6AD, UK

Tel: +44 (0) 191 565 5348 Fax: +44 (0) 191 564 0002 Email: sales@tigerfiltration.co.uk

Tiger Filtration Ltd

Alternative Filter Elements

Puska

Alternative filter elements manufactured by **Tiger Filtration Ltd** to fit into **Puska** filter housings



Tiger P/No.	Puska P/No.	List Price £
PK10 (*)	(*) 10	33.00
PK13 (*)	(*) 13	41.00
PK20 (*)	(*) 20	50.00
PK33 (*)	(*) 33	63.00
PK60 (*)	(*) 60	86.00
PK85 (*)	(*) 85	104.00
PK130 (*)	(*) 130	131.00
PK170 (*)	(*) 170	161.00
PK250 (*)	(*) 250	183.00

(*) = grade - Example: PMO10 order as PK10 M1
M3 replaces PRO (3 Micron)
M1 replaces PMO (1 Micron)
MX replaces PMM (0.01 Micron)
AC replaces PCA (Activated Carbon)



Tiger Filtration Ltd

Units 4a & 4b, East Way, Rivergreen Industry Centre, Pallion, Sunderland, SR4 6AD, UK

Tel: +44 (0) 191 565 5348 Fax: +44 (0) 191 564 0002 Email: sales@tigerfiltration.co.uk

Tiger Filtration Ltd

Alternative Filter Elements

Rietschle

Alternative filter elements manufactured by **Tiger Filtration Ltd** to fit into **Rietschle** vacuum pumps



Tiger P/No.	Rietschle P/No.	Previous Model	List Price £
RT399	731-399	730-946	38.00
RT400	731-400	730-936	38.00
RT401	731-401	730-937	49.00

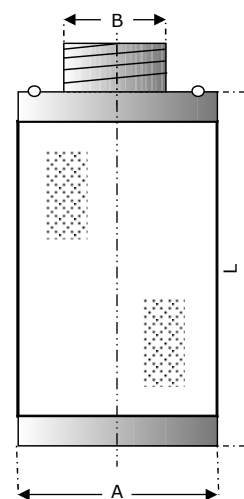

Tiger P/No.	A (mm)	B (mm)	L (mm)
RT399	56	M24	78
RT400	72	M33	83
RT401	80	M45	127



Tiger Filtration Ltd
 Units 4a & 4b, East Way, Rivergreen Industry Centre, Pallion, Sunderland, SR4 6AD, UK
 Tel: +44 (0) 191 565 5348 Fax: +44 (0) 191 564 0002 Email: sales@tigerfiltration.co.uk

Tiger Filtration Ltd

Alternative Filter Elements

Sullair

Alternative filter elements manufactured by **Tiger Filtration Ltd** to fit into **Sullair** filter housings



Grade M1		1 Micron
Tiger P/No.	Sullair P/No.	List Price £
SU423 M1	250024-423	36.00
SU424 M1	250024-424	59.00
SU425 M1	250024-425	69.00
SU426 M1	250024-426	85.00
SU427 M1	250024-427	112.00
SU428 M1	250024-428	134.00
SU429 M1	250024-429	192.00
SU644 M1	250024-644	227.00
SU430 M1	250024-430	307.00

Grade MX		0.01 Micron
Tiger P/No.	Sullair P/No.	List Price £
SU431 MX	250024-431	36.00
SU432 MX	250024-432	59.00
SU433 MX	250024-433	69.00
SU434 MX	250024-434	85.00
SU435 MX	250024-435	112.00
SU436 MX	250024-436	134.00
SU437 MX	250024-437	192.00
SU655 MX	250024-655	227.00
SU438 MX	250024-438	307.00

Grade AC		Activated Carbon
Tiger P/No.	Sullair P/No.	List Price £
SU443 AC	250024-443	36.00
SU444 AC	250024-444	59.00
SU445 AC	250024-445	69.00
SU446 AC	250024-446	85.00
SU447 AC	250024-447	112.00
SU439 AC	250024-439	134.00
SU440 AC	250024-440	192.00
SU646 AC	250024-646	227.00
SU441 AC	250024-441	307.00



Tiger Filtration Ltd

Units 4a & 4b, East Way, Rivergreen Industry Centre, Pallion, Sunderland, SR4 6AD, UK

Tel: +44 (0) 191 565 5348 Fax: +44 (0) 191 564 0002 Email: sales@tigerfiltration.co.uk

Tiger Filtration Ltd

Alternative Filter Elements

Ultrafilter (90 Series)

Alternative filter elements manufactured by **Tiger Filtration Ltd** to fit into **Ultrafilter (90 Series)** filter housings



Standard Elements

Tiger P/no.	UF P/No.	List Price £
UF0205 (*)	(*) 02/05	41.00
UF0210 (*)	(*) 02/10	42.00
UF0305 (*)	(*) 03/05	46.00
UF0310 (*)	(*) 03/10	51.00
UF0410 (*)	(*) 04/10	57.00
UF0420 (*)	(*) 04/20	67.00
UF0520 (*)	(*) 05/20	76.00
UF0525 (*)	(*) 05/25	86.00
UF0725 (*)	(*) 07/25	100.00
UF0730 (*)	(*) 07/30	118.00
UF1030 (*)	(*) 10/30	147.00
UF1530 (*)	(*) 15/30	164.00
UF2030 (*)	(*) 20/30	192.00
UF3030 (*)	(*) 30/30	262.00
UF3050 (*)	(*) 30/50	386.00

(*) = grade - Example: FF02/05 order as UF0205 M1
 M25 replaces V-PE (25 Micron)
 M1 replaces FF (1 Micron)
 M0 replaces MF (0.1 Micron & oil removal)
 MX replaces SMF (0.01 Micron & 0.01mg/m³ oil removal)
 AC replaces AK (Activated Carbon)

HT/CR or HT/NX Range

Tiger P/no.	UF P/No.	List Price £
UFHT0205 (*)	(*) 02/05	P.O.A.
UFHT0305 (*)	(*) 03/05	P.O.A.
UFHT0310 (*)	(*) 03/10	P.O.A.
UFHT0410 (*)	(*) 04/10	P.O.A.
UFHT0420 (*)	(*) 04/20	P.O.A.
UFHT0520 (*)	(*) 05/20	P.O.A.
UFHT0525 (*)	(*) 05/25	P.O.A.
UFHT0725 (*)	(*) 07/25	P.O.A.
UFHT0730 (*)	(*) 07/30	P.O.A.
UFHT1030 (*)	(*) 10/30	P.O.A.
UFHT1530 (*)	(*) 15/30	P.O.A.
UFHT2030 (*)	(*) 20/30	P.O.A.
UFHT3030 (*)	(*) 30/30	P.O.A.
UFHT3050 (*)	(*) 30/50	P.O.A.

(*) = grade - Example: FF02/05 order as UFHT0205 M1
 M1 replaces FF (1 Micron)
 M0 replaces MF (0.1 Micron & oil removal)
 MX replaces SMF (0.01 Micron & 0.01mg/m³ oil removal)



Tiger Filtration Ltd
 Units 4a & 4b, East Way, Rivergreen Industry Centre, Pallion, Sunderland, SR4 6AD, UK
 Tel: +44 (0) 191 565 5348 Fax: +44 (0) 191 564 0002 Email: sales@tigerfiltration.co.uk

Tiger Filtration Ltd

Alternative Filter Elements

Ultrafilter (80 Series)

Alternative filter elements manufactured by **Tiger Filtration Ltd** to fit into **Ultrafilter (80 Series)** filter housings



Standard Elements

Tiger P/No.	UF P/No.	List Price £
UF425 (*)	(*) 4/2.5	85.00
UF53 (*)	(*) 5/3	114.00
UF103 (*)	(*) 10/3	145.00
UF153 (*)	(*) 15/3	164.00
UF203 (*)	(*) 20/3	189.00
UF303 (*)	(*) 30/3	237.00
UF305 (*)	(*) 30/5	366.00

(*) = grade - Example: FF4/2.5 order as UF425 M1
M25 replaces V (25 Micron)
M1 replaces FF (1 Micron)
M0 replaces MF (0.1 Micron & oil removal)
MX replaces SMF (0.01 Micron & 0.01mg/m³ oil removal)
AC replaces AK (Activated Carbon)

HT/CR or HT/NX Range

Tiger P/No.	UF P/No.	List Price £
UFHT 103 (*)	(*) 10/3	P.O.A.
UFHT 153 (*)	(*) 15/3	P.O.A.
UFHT 203 (*)	(*) 20/3	P.O.A.
UFHT 303 (*)	(*) 30/3	P.O.A.
UFHT 305 (*)	(*) 30/5	P.O.A.

(*) = grade - Example: FF103 order as UFHT103 M1
M1 replaces FF (1 Micron)
M0 replaces MF (0.1 Micron & oil removal)
MX replaces SMF (0.01 Micron & 0.01mg/m³ oil removal)



Tiger Filtration Ltd
Units 4a & 4b, East Way, Rivergreen Industry Centre, Pallion, Sunderland, SR4 6AD, UK
Tel: +44 (0) 191 565 5348 Fax: +44 (0) 191 564 0002 Email: sales@tigerfiltration.co.uk

Tiger Filtration Ltd

Alternative Filter Elements



Walker

Alternative filter elements manufactured by **Tiger Filtration Ltd** to fit into **Walker** filter housings

Tiger P/No.	Walker P/No.	List Price £
WF361 (*)	E361 (*)	35.00
WF381 ACC	E381 AC	26.00
WF371 (*)	E371 (*)	48.00
WF511 (*)	E511 (*)	58.00
WF711 (*)	E711 (*)	84.00
WF811 (*)	E811 (*)	100.00
WF731 (*)	E731 (*)	113.00
WF821 (*)	E821 (*)	127.00
WF831 (*)	E831 (*)	153.00
WF851 (*)	E851 (*)	189.00
WF1251 (*)	E1251 (*)	225.00
WF1261 (*)	E1261 (*)	296.00
WF1281 (*)	E1281 (*)	350.00
WF139 (*)	E139 (*)	391.00
WF88 (*)	E88 (*)	211.00

(*) = grade - Example: E361 X1 order as WF361 M1
 M25 replaces X25 (25 Micron)
 M5 replaces X5 (5 Micron)
 M1 replaces X1 (1 Micron)
 MX replaces XA (0.01 micron)
 AC replaces AC (Activated Carbon)

Medical Vacuum Elements

Tiger P/No.	Walker P/No.	List Price £
WF511 MV	E511 MV	58.00
WF521 MV	E521 MV	76.00
WF811 MV	E811 MV	100.00
WF821 MV	E821 MV	127.00
WF831 MV	E831 MV	153.00
WF851 MV	E851 MV	189.00
WF1261 MV	E1261 MV	296.00
WF1281 MV	E1281 MV	350.00
WF139 MV	E139 MV	510.00
WF88 MV	E88 MV	232.00

High Pressure Elements - 50 Barg

Tiger P/No.	Walker P/No.	List Price £
WF50 (*)	E50 (*)	47.00
WF51 (*)	E51 (*)	58.00
WF52 (*)	E52 (*)	64.00
WF715 (*)	E715 (*)	84.00
WF730 (*)	E730 (*)	113.00
WF830 (*)	E830 (*)	127.00
WF86 (*)	E86 (*)	183.00

High Pressure Elements - 100 Barg

Tiger P/No.	Walker P/No.	List Price £
WFHP371 (*)	HP371 (*)	80.00
WFHP381 (*)	HP381 (*)	97.00
WFHP420 (*)	HP420 (*)	116.00
WFHP710 (*)	HP710 (*)	142.00
WFHP730 (*)	HP730 (*)	166.00
WFHP830 (*)	HP830 (*)	182.00
WFHP860 (*)	HP860 (*)	251.00

High Pressure Elements - 350 Barg

Tiger P/No.	Walker P/No.	List Price £
WFHP261 (*)	HP261 (*)	59.00
WFHP371 (*)	HP371 (*)	80.00
WFHP410 (*)	HP410 (*)	98.00
WFHP420 (*)	HP420 (*)	116.00
WFHP710 (*)	HP710 (*)	142.00
WFHP730 (*)	HP730 (*)	166.00

(*) = grade - Example: E50 X1 order as WF50 M1
 M25 replaces X25 (25 Micron)
 M5 replaces X5 (5 Micron)
 M1 replaces X1 (1 Micron)
 MX replaces XA (0.01 micron)
 AC replaces AC (Activated Carbon)



Tiger Filtration Ltd

Units 4a & 4b, East Way, Rivergreen Industry Centre, Pallion, Sunderland, SR4 6AD, UK

Tel: +44 (0) 191 565 5348 Fax: +44 (0) 191 564 0002 Email: sales@tigerfiltration.co.uk

Tiger Filtration Ltd

Alternative Filter Elements

Walker - Previous

Alternative filter elements manufactured by **Tiger Filtration Ltd** to fit into **Walker** filter housings



Tiger P/No.	Walker P/No.	List Price £
WF50 (*)	E50 (*)	47.00
WF51 (*)	E51 (*)	58.00
WF52 (*)	E52 (*)	64.00
WF71 (*)	E71 (*)	84.00
WF81 (*)	E81 (*)	99.00
WF73 (*)	E73 (*)	113.00
WF83 (*)	E83 (*)	127.00
WF103 (*)	E103 (*)	153.00
WF123 (*)	E123 (*)	187.00
WF125 (*)	E125 (*)	225.00
WF134 (*)	E134 (*)	189.00
WF135 (*)	E135 (*)	225.00
WF127 (*)	E127 (*)	297.00
WF128 (*)	E128 (*)	350.00
WF830 (*)	E830 (*)	127.00
WF86 (*)	E86 (*)	183.00
WF87 (*)	E87 (*)	198.00
WF137 (*)	E137 (*)	283.00
WF138 (*)	E138 (*)	358.00

(*) = grade - Example: E50 X1 order as WF50 M1
M25 replaces X25 (25 Micron)
M5 replaces X5 (5 Micron)
M1 replaces X1 (1 Micron)
MX replaces XA (0.01 micron)
AC replaces AC (Activated Carbon)

Medical Vacuum Elements

Tiger P/No.	Walker P/No.	List Price £
WF27 MV	E27 MV	45.00
WF37 MV	E37 MV	54.00
WF57 MV	E57 MV	68.00
WF81 MV	E81 MV	96.00
WF83 MV	E83 MV	144.00
WF103 MV	E103 MV	173.00
WF133 MV	E133 MV	211.00
WF137 MV	E137 MV	270.00
WF138 MV	E138 MV	302.00

High Pressure Elements

Tiger P/No.	Walker P/No.	List Price £
WFHP260 (*)	HP260 (*)	59.00
WFHP310 (*)	HP310 (*)	80.00

(*) = grade - Example: HP260 X1 order as WFHP260 M1
M25 replaces X25 (25 Micron)
M5 replaces X5 (5 Micron)
M1 replaces X1 (1 Micron)
MX replaces XA (0.01 micron)
AC replaces AC (Activated Carbon)



Tiger Filtration Ltd

Units 4a & 4b, East Way, Rivergreen Industry Centre, Pallion, Sunderland, SR4 6AD, UK

Tel: +44 (0) 191 565 5348 Fax: +44 (0) 191 564 0002 Email: sales@tigerfiltration.co.uk

Tiger Filtration Ltd

Alternative Filter Elements

Worthington Creyssensac

Alternative filter elements manufactured by **Tiger Filtration Ltd** to fit into **Worthington Creyssensac** filter housings



Tiger P/No.	Worthington P/No.	List Price £
WC60 (*)	D60 (*)	33.00
WC80 (*)	D80 (*)	41.00
WC120 (*)	D120 (*)	50.00
WC200 (*)	D200 (*)	63.00
WC340 (*)	D340 (*)	86.00
WC510 (*)	D510 (*)	104.00
WC800 (*)	D800 (*)	131.00
WC1000 (*)	D1000 (*)	161.00
WC1500 (*)	D1500 (*)	183.00
WC2400 (*)	D2400 (*)	263.00

(*) = grade - Example: D60 D order as WC60 M1

M3 replaces P (3 Micron)

M1 replaces D (1 Micron)

M0 replaces M (0.1 Micron)

MX replaces S (0.01 Micron)

AC replaces A (Activated Carbon)



Tiger Filtration Ltd

Units 4a & 4b, East Way, Rivergreen Industry Centre, Pallion, Sunderland, SR4 6AD, UK

Tel: +44 (0) 191 565 5348 Fax: +44 (0) 191 564 0002 Email: sales@tigerfiltration.co.uk

Tiger Filtration Ltd

Alternative Filter Elements

Zander (Parker)

Alternative filter elements manufactured by **Tiger Filtration Ltd** to fit into **Zander (Parker)** filter housings



Tiger P/No.	Zander P/No.	List Price £
ZA103 (*)	1030 (*)	52.00
ZA105 (*)	1050 (*)	62.00
ZA107 (*)	1070 (*)	73.00
ZA114 (*)	1140 (*)	89.00
ZA201 (*)	2010 (*)	118.00
ZA202 (*)	2020 (*)	152.00
ZA203 (*)	2030 (*)	189.00
ZA205 (*)	2050 (*)	243.00
ZA305 (*)	3050 (*)	287.00
ZA307 (*)	3075 (*)	335.00
ZA506 (*)	5060 (*)	461.00
ZA507 (*)	5075 (*)	556.00

(*) = grade - Example: 1050 Z order as ZA105 M1

M5 replaces V (5 Micron)

M1 replaces Z (1 Micron)

M0 replaces Y (0.1 Micron)

MX replaces X (0.01 Micron & 0.01mg/m³ oil removal)

AC replaces A (Activated Carbon)



Tiger Filtration Ltd

Units 4a & 4b, East Way, Rivergreen Industry Centre, Pallion, Sunderland, SR4 6AD, UK

Tel: +44 (0) 191 565 5348 Fax: +44 (0) 191 564 0002 Email: sales@tigerfiltration.co.uk

Tiger Filtration Ltd

Alternative Filter Elements

Zeks

Alternative filter elements manufactured by **Tiger Filtration Ltd** to fit into **Zeks** filter housings



Tiger P/No.	Zeks P/No.	List Price £
ZK15 (*)	E15 (*)	27.00
ZK30 (*)	E30 (*)	28.00
ZK32 (*)	E32 (*)	29.00
ZK65 (*)	E65 (*)	37.00
ZK80 (*)	E80 (*)	50.00
ZK100 (*)	E100 (*)	64.00
ZK150 (*)	E150 (*)	75.00
ZK250 (*)	E250 (*)	131.00
ZK300 (*)	E300 (*)	140.00
ZK500 (*)	E500 (*)	176.00
ZK650 (*)	E650 (*)	185.00
ZK1000 (*)	E1000 (*)	240.00
ZK1250 (*)	E1250 (*)	264.00
ZK1600 (*)	E1600 (*)	353.00

(*) = grade - Example: E15 G order as ZK15 M1
M5 replaces P (5 Micron)
M1 replaces G (1 Micron)
MX replaces H (0.01 Micron & 0.01mg/m³ oil removal)
AC replaces A (Activated Carbon)



Tiger Filtration Ltd

Units 4a & 4b, East Way, Rivergreen Industry Centre, Pallion, Sunderland, SR4 6AD, UK

Tel: +44 (0) 191 565 5348 Fax: +44 (0) 191 564 0002 Email: sales@tigerfiltration.co.uk